



# DUCATI energia

## CONDENSATORI PER MOTORI

## MOTOR CAPACITORS



## INDICE

## CONTENTS

Informazioni generali	<b>3</b>	General information
Condensatori in polipropilene metallizzato in custodia plastica serie 4.16.18/.10/.17/.20/.87	<b>7</b>	Metallized polypropylene film capacitors in plastic case series 4.16.18/.10/.17/.20/.87
Condensatori in polipropilene metallizzato in custodia metallica serie 4.16.27/.25/.33/.26	<b>17</b>	Metallized polypropylene film capacitors in metallic case series 4.16.27/.25/.33/.26
Condensatori elettrolitici per avviamento motori monofase serie 4.12.80	<b>25</b>	Single phase motor starting electrolytic capacitors series 4.12.80
Confezioni	<b>29</b>	Packages

## Caratteristiche elettriche, prestazioni e definizioni

### Tensione nominale $V_n$

È il valore efficace della tensione alternata sinusoidale che può essere applicata al condensatore nelle normali condizioni di lavoro.

### Corrente nominale $I_n$

È il valore della corrente che passa nel condensatore di capacità nominale alla tensione e alla frequenza nominale.

### Gamma di frequenza di impiego

I condensatori possono essere usati per un campo di frequenza di 50-60 Hz. È possibile l'impiego a frequenze maggiori purché vengano rispettati i limiti per tensione, corrente, temperatura e potenza.

### Categoria di temperatura di funzionamento

Minima temperatura  $-25^{\circ}\text{C}$ .

Massima temperatura  $+70^{\circ}\text{C}$  o  $+85^{\circ}\text{C}$ .

In conformità con le norme citate, tali temperature devono essere intese come quelle misurate sulla superficie del condensatore.

### Temperatura di stoccaggio

$-40^{\circ}\dots +85^{\circ}\text{C}$ .

### Tolleranza di capacità

Capacità nominale,  $\pm 5\%$

Valori differenti di tolleranza sono disponibili a richiesta.

### Angolo di perdita $\tan\delta$

Il valore della tangente dell'angolo di perdita misurato a 50Hz,  $20^{\circ}\text{C}$  alla tensione nominale, deve risultare:

$$\tan\delta \leq 20 \cdot 10^{-4}$$

### Massimi sovraccarichi ammessi

I condensatori possono funzionare nelle seguenti condizioni di sovraccarico per tutta la gamma di temperature di categoria.

$$I_{\max} = 1,3 I_n$$

$$V_{\max} = 1,1 V_n$$

Il sovraccarico derivante dalla presenza contemporanea di tensione e corrente con valori superiori a quelli nominali anche se contenuti nei limiti previsti, deve essere tale che la potenza apparente  $P_a$  ( $I_{\text{eff}} \times V_{\text{eff}}$ ) assorbita dal condensatore risulti di:

$$P_a \leq 1,35 \cdot 2\pi f \cdot C \cdot V_n^2$$

### Sollecitazioni impulsive

I condensatori sono in grado di sopportare onde a fronte ripido con una velocità massima di variazione della tensione di  $20 \text{ V} / \mu\text{s}$ .

### Resistenza di isolamento tra i terminali e la custodia

Misurato a  $500 \text{ Vcc}$ ,  $20^{\circ}\text{C}$  dopo 30 secondi

$$R_i > 1000 \text{ Mohm}$$

### Funzionamento in corrente continua

Questi condensatori possono essere utilizzati con una tensione continua non superiore al valore di picco della tensione nominale.

$$V_{\text{cc}} \leq \sqrt{2} V_n$$

Condensatori per tensione continua più elevata sono disponibili a richiesta.

## Electrical specifications and definitions

### Rated voltage $V_n$

The rms value of the sinusoidal AC voltage which can be applied to the capacitor in normal working conditions.

### Rated current $I_n$

The value of the current flowing through the capacitor of rated capacitance at the rated voltage and frequency.

### Duty frequency range

The capacitors can be used at a frequency range of 50-60Hz. Use at higher frequencies is possible provided the voltage, current, temperature and power limits are complied with.

### Operating temperature class

Minimum temperature  $-25^{\circ}\text{C}$ .

Maximum temperature  $+70^{\circ}\text{C}$  or  $+85^{\circ}\text{C}$ .

In accordance with the reference standards, these temperatures are those measured on the surface of the capacitor.

### Storage temperature

$-40^{\circ}\dots +85^{\circ}\text{C}$

### Capacitance tolerance

Rated tolerance  $\pm 5\%$

Different tolerance values are available on request.

### Loss angle $\tan\delta$

The value of the tangent of the loss factor measured at 50 Hz,  $20^{\circ}\text{C}$  at the rated voltage is:

$$\tan\delta \leq 20 \cdot 10^{-4}$$

### Maximum permissible overloads

The capacitors can operate in the following overload conditions throughout the temperature class range:

$$I_{\max} = 1.3 I_n$$

$$V_{\max} = 1.1 V_n$$

The overload deriving from the simultaneous presence of voltage and current above the rated values, even if within the stated limits, must be such that the apparent power  $P_a$  ( $I_{\text{rms}} \times V_{\text{rms}}$ ) absorbed by the capacitor is:

$$P_a \leq 1.35 \cdot 2\pi f \cdot C \cdot V_n^2$$

### Pulsed stress

The capacitors are capable of withstanding steep wavefronts with a maximum voltage variation speed of  $20 \text{ V} / \mu\text{s}$ .

### Insulation resistance between terminals and case

Measured at  $500 \text{ Vdc}$ ,  $20^{\circ}\text{C}$  after 30 seconds.

$$R_i > 1000 \text{ Mohm}$$

### Direct current operation

These capacitors can be used with a DC voltage not exceeding the peak value of the rated voltage.

$$V_{\text{dc}} \leq \sqrt{2} V_n$$

Capacitors for higher DC voltages are available on request.

## Composizione del numero di catalogo

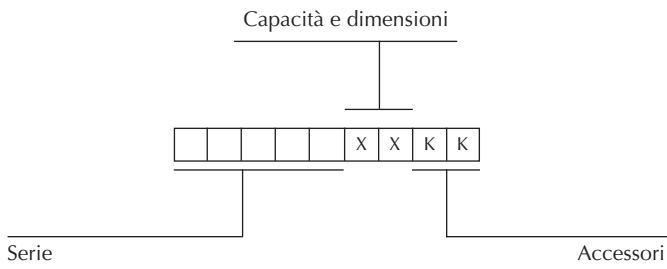

### Caratteristiche meccaniche

#### Fissaggio:

I condensatori possono essere provvisti di codolo M8 e M12.

Il massimo momento torcente è: 5 Nm per codolo M8  
12 Nm per codolo M12

#### Vibrazioni:

In conformità con le norme IEC 68-2-6, i condensatori superano la prova con una gamma di frequenza da 10 a 55 Hz una ampiezza di accelerazione di 10g e la durata di 6h.

## Andamento tipico delle caratteristiche elettriche del film polipropilene metallizzato in funzione della temperatura

### Angolo di perdita Dissipation factor

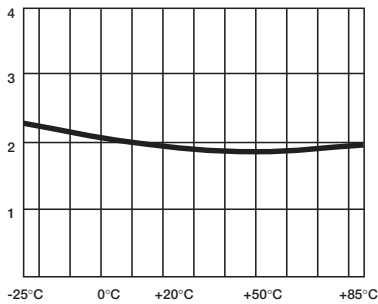

### Costante dielettrica Dielectric constant

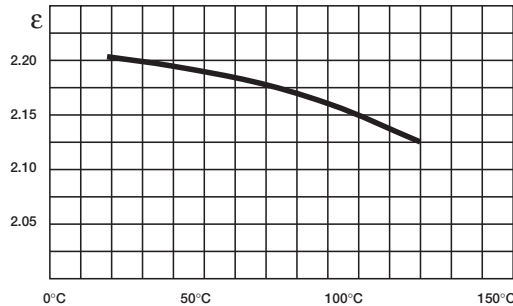

### Resistenza di isolamento Insulation resistance

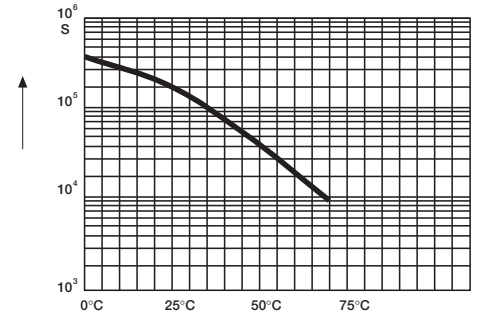

## Gradi di protezione secondo le norme IEC EN 60529 (IPXY)

1° Codice X	Grado di protezione
0	Non protetto
1	Protetto contro gli oggetti solidi maggiori di 50 mm
2	Protetto contro gli oggetti solidi maggiori di 12 mm
3	Protetto contro gli oggetti solidi maggiori di 2,5 mm
4	Protetto contro gli oggetti solidi maggiori di 1,0 mm
5	Protetto contro la polvere
2° Codice Y	Grado di protezione
0	Non protetto
1	Protetto contro la caduta verticale di gocce d'acqua
2	Protetto contro la caduta verticale di gocce d'acqua (inclinazione max 15°)
3	Protetto contro la caduta d'acqua a pioggia
4	Protetto contro gli spruzzi d'acqua
5	Protetto contro i getti d'acqua

## Part number composition

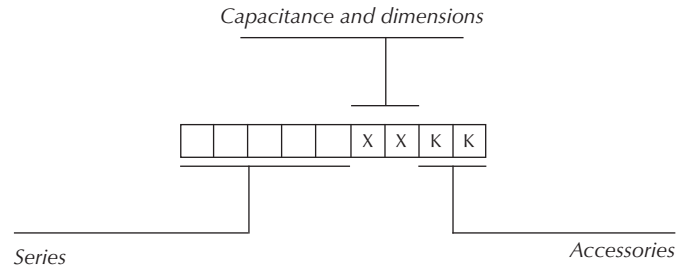

### Mechanical specifications

#### Mounting:

The capacitors may be provided with stud M8 and M12 for mounting:

The maximum torque is: 5 Nm for M8  
12 Nm for M12

#### Vibrations:

In accordance with IEC 68-2-6 standards, the capacitors pass the test with a frequency range from 10 to 55 Hz, acceleration amplitude 10 g and duration 6 h.

## Typical performance of electrical characteristics of metallized polypropylene film vs. temperature

## Protection degrees according to IEC publication IEC EN 60529 (IPXY)

1st code letter X	Protection degree
0	Not protected
1	Protected against solid objects greater than 50 mm
2	Protected against solid objects greater than 12 mm
3	Protected against solid objects greater than 2.5 mm
4	Protected against solid objects greater than 1.0 mm
5	Dust-protected
2nd code letter Y	Protection degree
0	Not protected
1	Protected against dripping water
2	Protected against dripping water when tilted up to 15°
3	Protected against spraying water
4	Protected against splashing water
5	Protected against water jets

### Classi di funzionamento (secondo DIN 40040)

Le classi di funzionamento per i condensatori sono riferite alle norme DIN 40040 (ed. Febbraio 1973) e sono identificate da 5 lettere che definiscono nell'ordine: temperatura minima, temperatura massima, umidità, vita probabile, tasso di guasto.

1 2 3 4 5	Temperatura limite inferiore <i>Temperature lower limit (°C)</i>	1 2 3 4 5	Temperatura limite superiore <i>Temperature upper limit (°C)</i>
1ª lettera <i>1st letter</i>		2ª lettera <i>2nd letter</i>	
F	-55	M	+100
G	-40	P	+85
H	-25	S	+70
J	-10	U	+60

1 2 3 4 5	Vita probabile (3) <i>Expected life (3) (ore/hours)</i>	Max % di guasto <i>Failure % max</i>
4ª e 5ª lettera <i>4th and 5th letter</i>		
QV	1.000	3
PU	3.000	
NT	10.000	
MS	30.000	

### Classi di funzionamento e categorie climatiche secondo la norma IEC/EN 60252-1

Le classi di funzionamento per i condensatori per motori monofase sono riferite alle norme EN 60252-1 (Giugno 2002) sono identificate nel seguente modo:

a) Classe vita prevista

	30.000 h classe A	10.000 h classe B	3.000 h classe C	1.000 h classe D
max % di guasto	3%	3%	3%	3%

b) Categorie climatiche

25	/	85	/	21
temperatura minima ammissibile		temperatura max ammissibile		giorni di prova caldo umido

c) Classe di sicurezza (prova di distruzione)

P0	Dispositivo di sicurezza non previsto
P1	Sicurezza ottenibile con dispositivo esterno (fusibile)
P2	Con dispositivo interno di interruzione

### Operating classes (DIN 40040)

According to DIN 40040 (ed. Feb. 1973), operating classes are identified by 5 letters which are defined consecutively: lower temperature, upper temperature, relative humidity, expected life, failure rate.

1 2 3 4 5	Umidità relativa (%) <i>Relative humidity (%)</i>		Condensazione ammessa <i>Acceptable condensation</i>
3ª lettera <i>3rd letter</i>	Valore max. <i>Maximum value</i>	Media annua <i>Year average</i>	
F (1)	95 (2)	≤75	no

(1) Con temperatura ambiente = 35° C;

(1) *Room temperature = 35° C;*

(2) Per 30 gg / anno max; negli altri giorni UR max = 85%;

(2) *For 30 days/year max; then max RH = 85%;*

(3) In servizio nominale e alla temperatura limite superiore.

(3) *On rated service and at upper temperature limit.*

### Operating classes and climatic categories IEC/EN 60252-1

Operating classes of capacitors for single-phase motors refer to EN 60252-1 Standards (June 2002) and are identified as follows:

a) Life expectancy

	30.000 h class A	10.000 h class B	3.000 h class C	1.000 h class D
failure % max	3%	3%	3%	3%

b) Climatic category

25	/	85	/	21
min. permissible temperature		max. permissible temperature		damp heat days

c) Class of safety protection

P0	No safety protection
P1	Safety achievable by external means (fuse)
P2	With internal safety protect

## Esempio di marcatura / Marking example

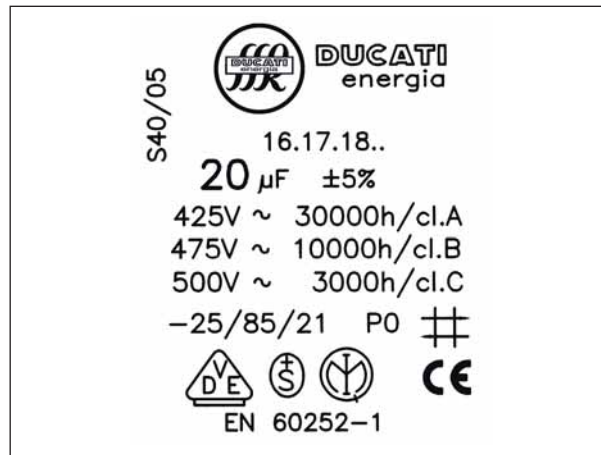

### QUALITÀ



L'attenzione massima alla qualità del prodotto e del servizio al cliente, è una costante nella storia della DUCATI ed è il fattore principale che ne ha reso noto il nome in tutto il mondo.

L'azienda è stata sempre fra le prime in Italia e, nel suo campo, in Europa ad adottare le normative e le procedure più moderne per garantire il livello massimo di qualità ed affidabilità dei prodotti.

Il SISTEMA QUALITÀ della Ducati Energia spa, sezione condensatori, descritto nel Manuale della Qualità è stato fra i primi in Italia ad essere approvato dal CSQ secondo le norme ISO 9001 (Certificato 9170 DUC 2).

Tutto ciò è stato ottenuto e viene garantito grazie a processi produttivi fortemente integrati ed automatizzati, macchine e tecnologie completamente nuove e innovative, metodologie del controllo del processo produttivo basato su accurate specifiche e sulla responsabilizzazione degli operatori a tutti i livelli.

Le serie attuali sono certificate secondo la normativa Europea EN 60252-1.

#### Nota relativa a direttiva RoHS

In linea con la direttiva Europea 2002/95/EC già nota come direttiva RoHS, tutti i condensatori prodotti dalla Ducati Energia S.p.A., già dal Giugno 2005, sono costruiti conformemente alla direttiva stessa.

#### Attenzione!

Un impiego scorretto o improprio, come l'uso del condensatore per applicazioni che comportano il superamento delle capacità e/o caratteristiche indicate nel catalogo, o l'uso del condensatore per applicazioni non adatte alle caratteristiche di quel particolare tipo di condensatore, può provocare un guasto irreversibile del condensatore medesimo. Questo può manifestarsi con l'esplosione del condensatore o l'espulsione. Il termine della vita del condensatore si manifesta con perdita di capacità, aumento del fattore di potenza e/o interruzione permanente del circuito. Si avverte pertanto l'utilizzatore che è necessario mettere in opera e provvedere ogni tipo di protezione o contenimento aggiuntivi che fossero necessari al fine di evitare ogni possibile tipo di danno a cose o persone in caso di guasto.

DUCATI energia SpA declina ogni responsabilità per danni a cose o persone derivanti dall'uso scorretto o improprio dei suoi prodotti.

### QUALITY

*The great attention to the product quality and to the customer service are constants in DUCATI's history and these are main factors which contribute to its success all over the world.*

*Ducati has always been one of the first companies, in its field, in Italy and in Europe to adopt the most modern standards and procedures in order to assure the highest level of the quality and reliability of products.*

*The QUALITY SYSTEM of Ducati Energia SpA, capacitor division, as described in Quality Manual, has been one of the first in Italy to be approved by CSQ according to ISO 9001 (Certificate 9170 DUC 2).*

*All is guaranteed thanks to fully automated and integrated processes, to completely new and innovative machines and technologies, to methodologies of the productive processes control based on accurate specifications and on responsible operator.*

*The averent series are certified according to the new European EN 60252-1 standard.*

#### Note relevant to RoHS directive

*In line with 2002/95/EC directive, already known as RoHS directive, all the capacitors produced by Ducati Energia S.p.A, since June 2005, are manufactured in compliance with the above directive.*

#### Warning!

*Misapplication, such as exceeding the design limits, use for applications different from those indicated in the catalogue or use for applications inappropriate for the characteristics of the type of capacitor used, may result in failure of the capacitor or in expulsion of the capacitor element from the case. Normal end of life failure is characterized by loss of capacitance increase in dissipation factor and/or permanent open circuit. The user is therefore cautioned to provide whatever additional protection or enclosure is necessary to avoid possible damage or injury in case of failure.*

*DUCATI energia SpA disclaims any responsibility for damages to things and people originated by an improper use of its products.*

**Condensatori in polipropilene  
metallizzato in custodia plastica  
serie 4.16.18/.10/.17/.20/.87**

***Metallized polypropylene film  
capacitors in plastic case  
series 4.16.18/.10/.17/.20/.87***



Il dielettrico è in film di polipropilene, le armature sono costituite da un sottilissimo deposito metallico ottenuto per evaporazione sotto vuoto.

Custodia e coperchio sono realizzati in materiale plastico autoestinguente: l'elemento capacitivo-sigillato con resina poliuretanic. Le caratteristiche principali di queste serie di condensatori sono:





- Avvolgimento antinduttivo a basse perdite
- Proprietà autorigeneranti che impediscono il cortocircuito
- Piccole dimensioni e peso contenuto
- Il condensatore è assolutamente esente da rischi di perdite di liquido.
- classe di sicurezza: P0

*The dielectric is polypropylene film, the electrodes consist of an extremely thin metal coating obtained by vacuum evaporation. Case and cover are made with self-extinguishing plastic material, the capacitive element is sealed with polyurethanic resin.*

*The main characteristics of these capacitors are:*

- *Low losses non-inductive winding*
- *Self-healing property avoiding short circuits*
- *Small size and limited weight*
- *No leakage risk.*
- *Class of safety protection: P0*

# Series 4.16.18

<b>Series 4.16.18</b>	Omologazioni / Approvals			
	EN 60252-1	 VDE	 IMQ	 ASE
	Tensione Voltage	250 V ~ 400 V ~ 425 V ~	10000 h cl.B 3000 h cl.C 1000 h cl.D	25/85/21 25/85/21 25/85/21
				Valori omologati Approved range 1 ÷ 70 µF 1 ÷ 25 µF 1 ÷ 25 µF
C (µF)	DxH (mm)	Codice / Part number 4.16.18.XX.KK	DxH** (mm)	Part number 4.16.18.XX.KK
1	25x50	4.16.18.01.KK		
1,5	"	.02.		
2	"	.03.		
2,5	"	.04.		
3	"	.05.		
3,15	"	.06.		
3,5	"	.07.		
4	"	.08.		
4,5	"	.09.		
5	25x55	.10.	28x55	16.18.52..
6	"	.11.	"	53..
6,3	30x55	.12.	"	54..
7	"	.13.	"	55..
7,5	"	.14.	"	56..
8	"	.15.	"	57..
9	"	.16.	32x55	58..
10	"	.17.	"	59..
11	"	.18.	"	60..
12	36x58	.19.	"	61..
12,5	"	.20.		
13	"	.21.		
13,5	"	.22.		
14	"	.23.		
15	"	.24.		
16	"	.25.		
17,5	36x70	.26.		
18	"	.27.		
20	"	.28.		
22	"	.29.		
25	40x70	.30.		
30	"	.31.		
31,5	40x92	.32.		
35	"	.33.		
40	"	.34.		
45	"	.35.		
50	45x92	.36.		
55	"	.37.		
60	"	.70.		
70	45x117	.39.		
80	"	.40.		
90	50x117	.41.		
100	"	.42.		
 <b>UL recognition</b> File E192559 250V~		Disponibile su richiesta Available on request		





\*\* Dimensioni alternative / Alternative dimensions

Omologazioni / Approvals						
<b>Series 4.16.10</b>	EN 60252-1					
	Tensione Voltage	VDE	IMQ	ASE	Valori omologati Approved range	
	400 V ~		10000 h	cl.B	25/85/21	45 ÷ 60 µF
	425 V ~		10000 h	cl.B	25/85/21	2 ÷ 40 µF
450 V ~		3000 h	cl.C	25/85/21	45 ÷ 60 µF	
475 V ~		3000 h	cl.C	25/85/21	2 ÷ 40 µF	
C (µF)	DxH (mm)	Part number 4.16.10.XX.KK	DxH** (mm)	Part number 4.16.10.XX.KK	DxH** (mm)	Part number 4.16.10.XX.KK
2	25x49	4.16.10.31.KK	28x55	4.16.10.01.KK	30x56	
2,5	25x49	.32.	28x55	.02.		
3	25x49	.33.	28x55	.03.	30x56	.74.
3,15	25x49	.34.	28x55	.04.		
3,5	25x55	.35.	28x55	.05.		
4	25x55	.37.	28x55	.06.	30x56	.38.
4,5	25x55	.C8.	28x55	.07.	30x56	.39.
5	30x56	.76.	28x55	.08.		
5,5	30x56	.41.				
6	30x56	.82.	32x55	.09.		
6,3	30x56	.83.	32x55	.10.		
7	30x56	.85.	32x55	.12.		
7,5	36x58	.44.	32x55	.89.		
8	36x58	.81.	32x55	.13.	30x70	.52.
9	36x58	.14.				
10	36x58	.15.	30x70	.47.		
11	36x58	.16.				
12	36x70	.17.				
12,5	36x70	.18.				
13	36x70	.19.				
14	36x70	.21.				
15	36x70	.22.				
16	36x70	.99.				
18	40x70	.24.				
20	40x70	.25.				
22	40x92	.68.				
25	40x92	.26.	45x70	.97.		
30	40x92	.70.				
31,5	45x92	.27.				
32	45x92	.72.				
35	45x92	.28.				
36	45x92	.65.				
40	45x92	.29.				
45	45x117	.63.	50x92	.90.		
50	45x117	.30.	50x92	.62.		
55	45x117	.64.	50x92	.86.		
60	50x117	.61.	55x92	.57.		
70	50x117	.67.				
80	55x120	.87.				

**UL recognition**  
 File E192559    Disponibile su richiesta  
**450V~**            Available on request



\*\* Dimensioni alternative / Alternative dimensions

# Series 4.16.17

Omologazioni / Approvals					
<b>Series 4.16.17</b>	<b>EN 60252-1</b>    VDE      IMQ      ASE				
	Tensione Voltage		Valori omologati Approved range		
	425 V~	30000 h cl.A	25/85/21	1 ÷ 45 µF	
	475 V~	10000 h cl.B	25/85/21	1 ÷ 70 µF	
500 V~	3000 h cl.C	25/85/21	1 ÷ 25 µF		
C (µF)	DxH (mm)	Part number 4.16.17.XX.KK	DxH** (mm)	Part number 4.16.17.XX.KK	
1	25x49	4.16.17.71.KK	28x55	4.16.17.01.KK	
1,5	25x49	.73.	28x55	.23.	
2	25x49	.74.	28x55	.02.	
2,5	25x55	.75.	28x55	.03.	
3	25x55	.77.	28x55	.04.	
3,15	25x55	.C2.	28x55	.05.	
3,5	25x55	.C3.	28x55	.06.	
4	30x56	.81.	28x55	.07.	
4,5	30x56	.82.			
5	30x56	.83.	32x55	.08.	
6	36x58	.99.	32x55	.09.	
6,3	36x58	.93.	32x55	.10.	
7	36x58	.11.			
7,5	36x58	.97.			
8	36x58	.12.			
9	36x70	.24.			
10	36x70	.13.			
12	40x70	.29.			
12,5	40x70	.30.			
14	40x70	.15.			
15	40x70	.26.			
16	40x92	.54.	45x70	.50.	
17,5	40x92	.59.			
18	40x92	.17.			
20	40x92	.18.	45x70	.68.	
22	40x92	.19.			
25	45x92	.25.			
30	45x92	.21.			
32	50x92	.22.			
35	50x92	.57.	45x117	.64.	
40	50x92	.58.	45x117	.27.	
50	50x117	.28.			
55	55x120	.66.			
60	55x120	.56.			
70	60x120	.62.			
<b>UL recognition</b>  File E192559      Disponibile su richiesta <b>400V~/450V~</b> Available on request					

\*\* Dimensioni alternative / Alternative dimensions

# Series 4.16.20

Omologazioni / Approvals						
<b>Series 4.16.20</b>	EN 60252-1   VDE IMQ					
	Tensione Voltage		<b>380 V 30000 h cl. A 25/70/21</b>		Classe di sicurezza: P0 Class of safety protection: P0	
C (μF)	DxH (mm)	Codice Part number 4.16.20.XX.KK	DxH** (mm)	Codice Part number 4.16.20.XX.KK	DxH** (mm)	Codice Part number 4.16.20.XX.KK
1					25x43	4.16.20.27.KK
1,5					»	.28.
2	25x50	4.16.20.21.KK	28x55	4.16.20.11.KK	»	.01.
2,5	»	.22.	»	.12.	»	.02.
3	»	.23.	»	.13.	»	.03.
3,15	»	.24.	»	.14.		
3,5	25x55	.05.	»	.15.		
4	»	.06.	»	.16.		
4,5	»	.07.	»	.17.		
5	30x56	.08.	»	.18.		
5,5	»	.09.	»	.19.		
6	»	.10.	»	.20.		

I condensatori della serie 16.87. sono condensatori per impiego in corrente alternata con dielettrico in film di polipropilene metallizzato.

L'elemento capacitivo è costruito con una innovativa tecnologia che utilizzando un film ad alta rigenerazione consente al condensatore di avere un elevato grado di protezione contro il pericolo di scoppio ed incendio.

In conformità con la normativa EN60252-1 i condensatori sono stati approvati con grado di protezione P2.



L'elemento capacitivo è sigillato con resina poliuretanic, custodia e coperchio sono in materiale plastico autoestinguento.

*The capacitors series 16.87 are conceived to be used in alternated current, with dielectric in a metalized polypropylene film.*

*The capacitive element is the result of an innovative technology, which permits the capacitor to have a high degree of protection against any risk of burst or fire thanks to a high-regeneration film.*

*The capacitors have been approved with protection degree P2 in compliance with EN 60252-1 standard.*

*The capacitive element is sealed with polyurethan resin; case and cover are made from self-extinguishing plastic.*

Series 4.16.87.	Omologazioni / Approvals			
	EN 60252-1		  	
	Tensione Voltage	450 V ~ 10000 h cl. B 25/85/21		Classe di sicurezza: P2 Class of safety protection: P2
		400 V ~ 30000 h cl. A 25/85/21		
C (µF)	DxH (mm)	Codice / Part number 4.16.87.xx.kk	DxH (mm)	Part number 4.16.87.xx.kk
2	25x55	4.16.87.01.kk	28x55	4.16.87.21.kk
2,5	"	.02..	"	".22..
2,8	"	.03..	"	".23..
3	"	.04..	"	".24..
3,15	30x55	.05..	"	".25..
3,5	"	.06..	"	".26..
4	"	.07..	"	".27..
4,5	"	.08..	"	".28..
5	"	.09..	32x55	".29..
5,5	36x58	.10..	"	".30..
6	"	.11..	"	".31..
6,3	"	.12..		
7	"	.13..		
7,5	"	.14..		
8*	"	.15..		

\* Tolleranza capacità ±10%

\* Capacitance tolerance ±10%



## CARATTERISTICHE TECNICHE

Tolleranza di capacità	: ± 5%
Frequenza di lavoro	: 50 ÷ 60 Hz
Tensione di prova individuale	: Fra le armature: 2Vn per 2 sec; verso massa 3KV per 2 sec. (solo versioni codolo metallico)
Angolo di perdita tan δ	: <20 10 <sup>-4</sup> (20°C V=Vn, 50Hz)
Rivestimento	: Custodia e coperchio di chiusura in materiale plastico autoestinguente, grado V2 secondo UL 94
Terminali	: Terminali «Faston» 6,3 mm singolo, doppio, a innesto da 2,8 mm, cavo bipolare, cavetti unipolari
Grado di protezione	: Per esecuzione con terminali: IP00, per esecuzioni con cavo bipolare: IP55
Coperchio porta-terminali	: Test della sfera (IEC60695-10-2): 125°C Test del filo incandescente (IEC 60695-2-11): 850°C Resistenza alle correnti superficiali (IEC 60112): ≥ 250V
Codolo filettato di fissaggio	: Coppia massima di serraggio: 5 N m



## TECHNICAL CHARACTERISTIC

Capacitance tolerance	: ± 5%
Working frequency range	: 50 ÷ 60 Hz
Individual test voltage	: Between terminals: 2Vn for 2 sec.; between terminals and case: 3KV for 2 sec. (only for metallic stud)
Dissipation factor tan δ	: <20 10 <sup>-4</sup> (20°C V=Vn, 50Hz)
Protection	: Case and cover in self - extinguishing plastic material, grade V2 according to UL 94
Terminals	: Faston «terminals» 6.3 mm single, double, 2.8 mm plug-in, twin cable, unipolar leads
Protection degree	: with terminals: IP00; with twin cable IP55.
Cover	: Ball pressure test (IEC 60695-10-2): 125°C Glow wire test (IEC 60695-2-11): 850°C Tracking resistance (IEC 60112): ≥ 250V
Threaded fixing bolt	: Max torque: 5 N m

### Accessori kk per i modelli standard Accessories kk for standard models

Fig.	Descrizione Description	Serie - Series 4.16.18/.10/.17			
		 senza codolo without stud	 con codolo with stud	 fissaggio rapido fast fix	
1	Terminali Terminals	FASTON 6,3 mm doppio / double tag	60	64	71
2		FASTON 6,3 mm semplice / single tag	26	27	72
3		FASTON 2,8 mm a innesto / plug-in	00	40	
5	Cavo bipolare / twin cable L = 250 mm		10	14	
6	Cavetti unipolari / unipolar leads L = 150 mm		06	46	
Ø 28 e 32 Codolo M8 plastico / Plastic stud M8					
Ø 25, 30, 36 ÷ 60 Codolo M8 metallico / Metallic stud M8					

### Accessori kk per i modelli approvati UL Accessories kk for UL recognized models

Fig.	Descrizione Description	Serie - Series 4.16.18/.10/.17		
		 senza codolo without stud	 con codolo with stud	
1	Terminali Terminals	FASTON 6,3 mm doppio / double tag	EA	DA
2		FASTON 6,3 mm semplice / single tag	TA	SA
3		FASTON 2,8 mm a innesto / plug-in	BA	AA
5	Cavo bipolare / twin cable L = 250 mm		LA	KA
6	Cavetti unipolari / unipolar leads L = 150 mm		HA	GA
Ø 28 e 32 Codolo M8 plastico / Plastic stud M8				
Ø 25, 30, 36 ÷ 60 Codolo M8 metallico / Metallic stud M8				

Soluzioni meccaniche / Mechanical configuration

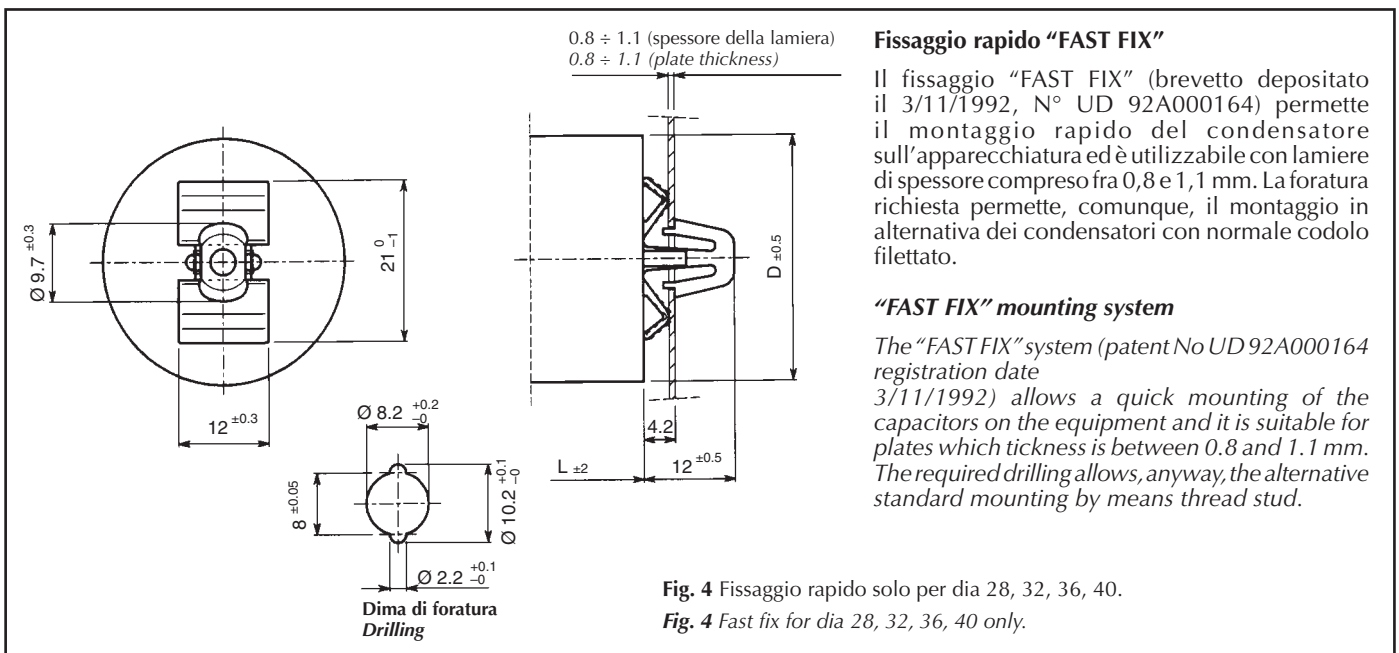
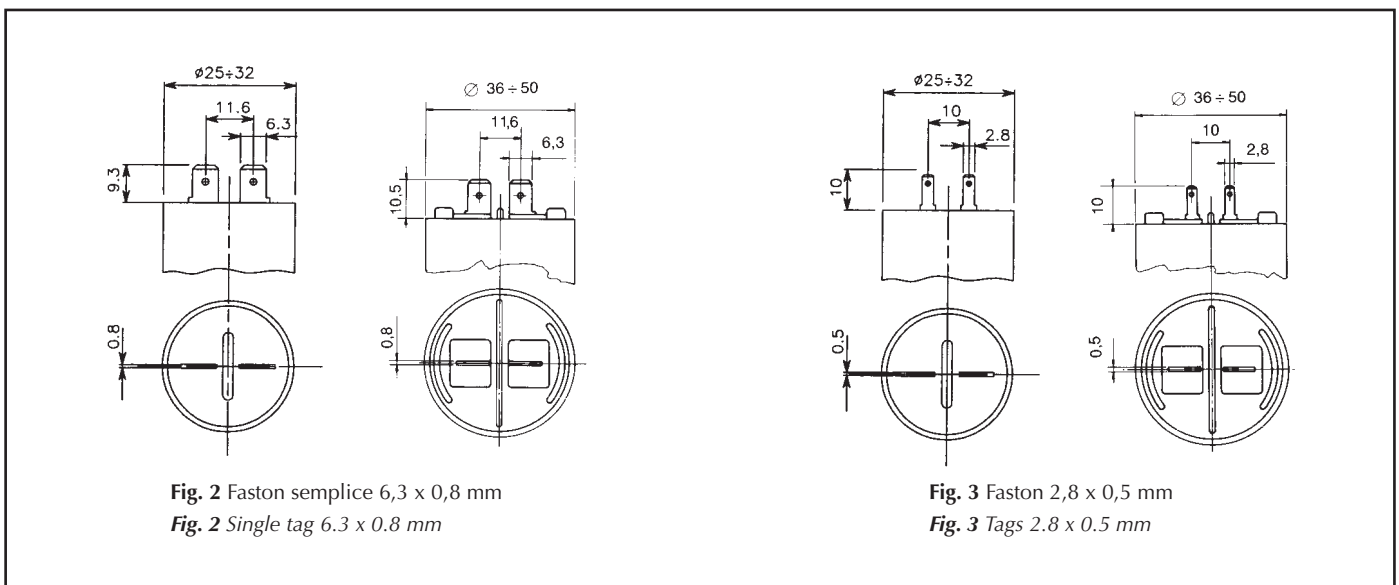
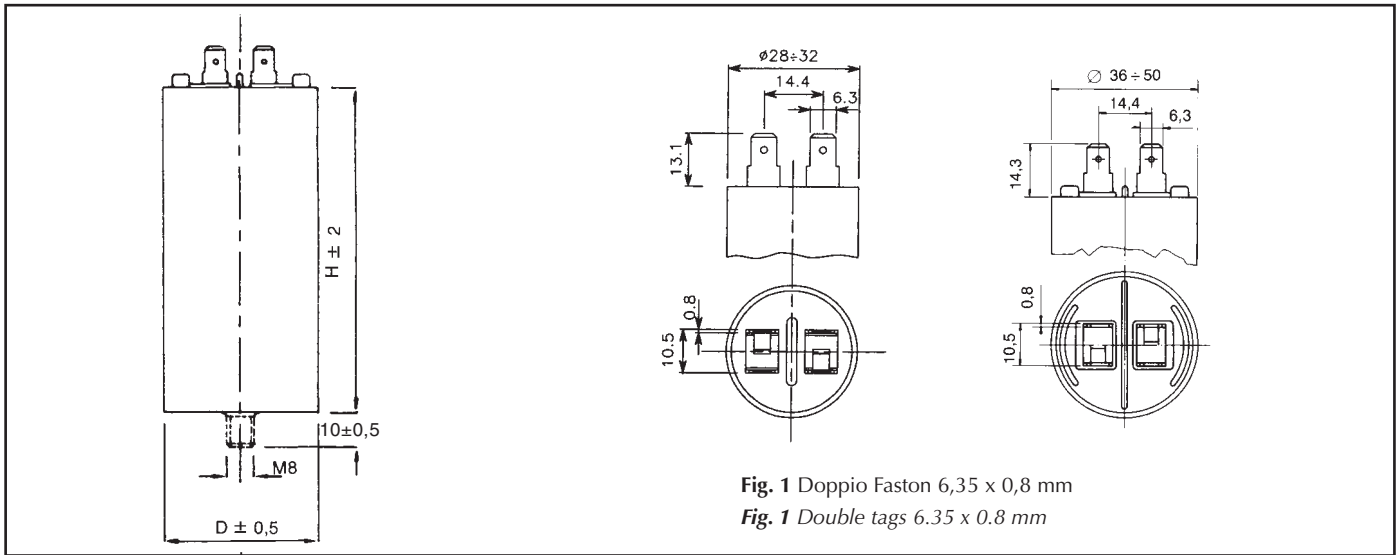

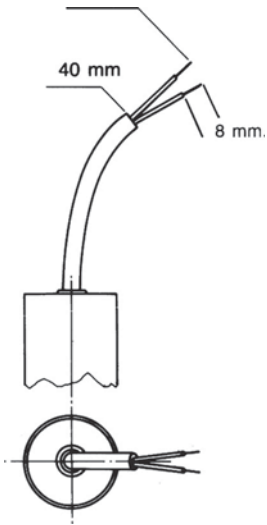

**Fig. 5** Cavo bipolare 2 x 0,75 mm<sup>2</sup>  
L = 250 mm

**Fig. 5** Twin cable 2 x 0,75 mm<sup>2</sup>  
L = 250 mm

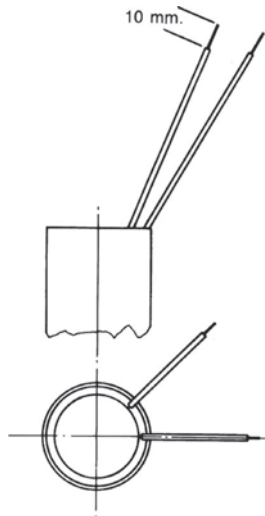

**Fig. 6** Cavetti unipolari 0,5mm<sup>2</sup>  
L = 150 mm

**Fig. 6** Insulated solid core leads  
0.5 mm<sup>2</sup> L = 150 mm

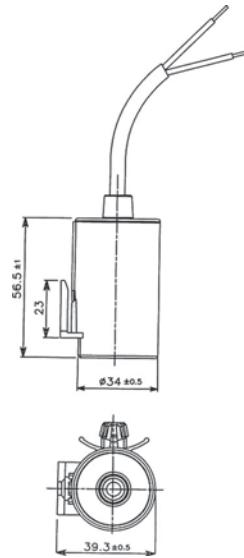

**Fig. 7** Versione multifix solo in  
dimensione Ø34x56,5

**Fig. 7** Multifix version only in  
dimension Ø34x56,5

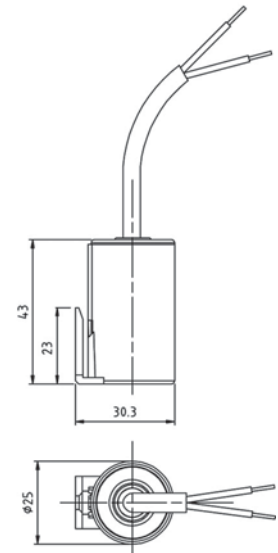

**Fig. 8** Versione con fissaggio a  
linguetta solo in dim. Ø25x43

**Fig. 8** Tang clamp version only in  
Ø 25x43 dimension.

Le versioni con cavo bipolare e cavetti a richiesta possono essere fornite di terminali di connessione.  
The versions with twin cable and leads may be equipped with connection tags on request.

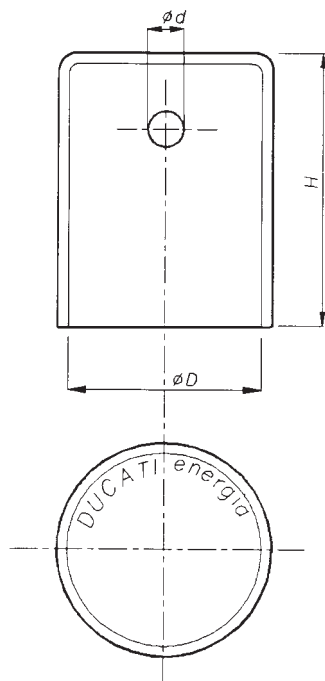

**Fig. 9** Cappello.  
**Fig. 9** Protective cap.

Ø D	H	Ø d	Codice / P/n
25	40	8	316.23.2210
28	50	8.5	316.23.0930
30	40	8.5	316.23.2301
32	50	8.5	316.23.0940
36	50	8.5	316.23.0950
40	50	8.5	316.23.0960
45	50	8.5	316.23.0860
50	50	8	316.23.1070
55	64	8	316.23.2110

## Condensatori in polipropilene metallizzato in custodia metallica serie 4.16.27/.25/.33/.26

## Metallized polypropylene film capacitors in metallic case series 4.16.27/.25/.33/.26



Il dielettrico è in film di polipropilene, le armature sono costituite da un sottilissimo deposito metallico ottenuto per evaporazione sotto vuoto.

Il condensatore è assolutamente esente da rischi di perdite.

Le custodie sono metalliche, i coperchi sono in materiale plastico autoestinguente (classe V2 in accordo con le norme U L-94).

La chiusura del condensatore è realizzata mediante bordatura della custodia sul coperchio che garantisce una perfetta ermeticità. L'adozione di un contenitore isolante posto tra l'elemento capacitivo e la custodia metallica, unitamente al bloccaggio dell'elemento capacitivo in resina, rendono il condensatore estremamente sicuro sia dal punto di vista elettrico (isolamento verso massa) che di insensibilità alle vibrazioni.

I condensatori 16.27/.25/.33/.26 sono dotati di un dispositivo di protezione contro il pericolo d'incendio conforme alle norme EN60252-1 (classe di protezione di sicurezza P2) e UL 810 (fig. 7). Il dispositivo di protezione è stato testato secondo le UL810 con una corrente di guasto da 5A fino a 10.000 A.

I condensatori sono inoltre certificati secondo le norme CSA 22.2 N. 190-M1985.

*The dielectric is polypropylene film, the electrodes consist of an extremely thin metal coating obtained by vacuum evaporation. The capacitor has no risks of leakage.*

*The cases are metallic, the covers are in self extinguishing plastic (class V2 to UL-94 standards).*

*The capacitor is sealed by an edging of the case on the cover, ensuring air-tight closure.*

*The use of an-insulating container between the capacitive element and the metal case, combined with the blocking of the capacitive element in resin, make the capacitor extremely safe both from the electric point of view (earthing insulation) and in terms of resistance to vibrations.*





*Series 16.27/.25/.33/.26 capacitors are equipped with a safety device in accordance with.*





*The capacitors are equipped with a protection device against fire danger in compliance with EN 60252-1 Standards (safety protection class P2) and UL 810 (Fig. 7).*





*The protection device has been tested according to UL 810 with a fault current ranging from 5A to 10.000 A.*





*Furthermore, the capacitors are certified in accordance with CSA 22.2 N. 190-M1985.*

# Series 4.16.27

Omologazioni / Approvals							
<b>Series 4.16.27</b>	EN 60252-1				 ASE	 File E102953	
	Tensione <i>Voltage</i>		10000h cl. B		25/85/21	Tensione <i>Voltage</i>	
	330V~				2 ÷ 60uF	240V~ 60Hz 4÷100uF 10.000 AFC -25 +70°C	
Classe di sicurezza: P2 / <i>Class of safety protection: P2</i>							
C (µF)	DxH (mm)	Part number 4.16.27.XX.KK	DxH (mm)	Part number 4.16.27.XX.KK	DxH (mm)	Part number 4.16.27.XX.KK	
2	25x60	4.16.27.33.KK	30x53	4.16.27.82.KK			
2,5	25x60	.34.	30x53	.83.			
3	25x60	.35.	30x53	.84.			
3,15	25x60	.36.	30x53	.85.			
3,5	25x60	.37.	30x53	.86.			
4	25x60	.38.	30x53	.87.	35x60	4.16.27.01.KK	
4,5	25x60	.39.	30x53	.88.	35x60	.73.	
5	30x53	.76.			35x60	.02.	
6	30x53	.77.			35x60	.03.	
6,3	30x53	.78.			35x60	.04.	
7	30x53	.79.			35x60	.05.	
7,5	30x60	.60.			35x60	.06.	
8	30x60	.44.			35x60	.07.	
9	35x60	.45.					
10	35x60	.08.					
12	35x60	.32.	30x72	.69.			
12,5	35x60	.09.					
13	35x60	.10.					
13,5	35x60	.11.					
14	35x72	.12.					
15	35x72	.13.					
16	35x72	.14.					
18	35x72	.15.					
20	40x72	.16.	35x77	.56.			
22	40x72	.17.					
25	40x72	.18.					
30	40x98	.19.					
31,5	40x98	.20.					
35	40x98	.21.					
40	40x98	.22.					
45	45x98	.23.					
50	45x98	.24.					
55	45x122	.25.					
60	45x122	.26.					
65	45x122	.27.					
70	45x122	.28.					
75	50x122	.29.					
80	50x122	.30.					
100	55x122	.31.					
110	55x122	.59.					

Omologazioni / Approvals							
<b>Series 4.16.25</b>	EN 60252-1					ASE	 File E102953
	Tensione Voltage					Valori omologati Approved range	Tensione Voltage
	425V~	10000h cl. B	25/85/21			1 ÷ 35uF	370V~
400V~	10000h cl. B	25/85/21			40 ÷ 60uF	60Hz 4÷70uF	
450V~	3000h cl. C	25/85/21			40 ÷ 60uF	10.000 AFC	
475V~	3000h cl. C	25/85/21			1 ÷ 35uF	-25 +70°C	
Classe di sicurezza: P2 / Class of safety protection: P2							
C (µF)	DxH (mm)	Part number 4.16.25.XX.KK	DxH (mm)	Part number 4.16.25.XX.KK	DxH (mm)	Part number 4.16.25.XX.KK	
1	25x60	4.16.25.01.KK					
1,5	25x60	.02.	30x60	4.16.25.42.KK			
2	25x60	.03.	30x60	.41.	35x53	4.16.25.45.KK	
2,5	25x60	.04.	30x60	.43.	35x53	.46.KK	
3	25x60	.33.	30x60	.44.	35x53	.47.	
3,15	30x53	.99..	30x60	.34..			
4	30x53	.A1..	30x60	.35..	35x53	4.16.25.48.KK	
4,5	30x53	.A2..	30x60	.36..			
5	30x60	.37.	25x72	.64.	35x53	.49.	
6	30x60	.38.			35x60	.07.	
6,3	35x60	.08.					
7	35x60	.09.	30x72	.95.			
7,5	35x60	.10.	30x72	.96.			
8	35x60	.11.	30x72	.40.			
9	35x60	.39.					
10	35x72	.12.					
12	35x72	.72.					
12,5	35x72	.13.					
13	35x72	.14.					
13,5	35x77	.81.	40x72	.15.			
14	35x77	.75.	40x72	.16.			
15	40x72	.17.					
16	40x72	.18.					
17,5	40x72	.83.					
18	40x72	.19.					
20	40x98	.20.					
22	40x98	.21.					
22,5	40x98	.82.					
25	40x98	.22.					
30	40x98	.23.					
31,5	45x98	.24.					
35	45x98	.25.					
40	45x122	.26.	50x98	.85.			
45	45x122	.27.					
50	45x122	.28.					
55	50x122	.29.					
60	50x122	.30.					
65	55x122	.31.					
70	55x122	.32.					

Omologazioni / Approvals							
<b>Series 4.16.33</b>	EN 60252-1					 File E102953	
	Tensione Voltage		ASE		Valori omologati Approved range		Tensione Voltage
	400V~	30000h cl. A	25/100/21	0,8÷10uF	400V~	60Hz 0,8÷60uF	
	425V~	30000h cl. A	25/85/21	0,8÷40uF	10.000 AFC	-25 +70°C	
475V~	10000h cl. B	25/85/21	0,8÷70uF				
500V~	3000h cl. C	25/85/21	0,8÷40uF				
Classe di sicurezza: P2 Class of safety protection: P2							
C (µF)	DxH (mm)	Part number 4.16.33.XX.KK	DxH (mm)	Part number 4.16.33.XX.KK	DxH (mm)	Part number 4.16.33.XX.KK	
0,8	25x60	4.16.33.01.KK.					
1	25x60	.02.	30x60	4.16.33.66.KK	35x53	4.16.33.67.KK	
1,5	25x60	.03.	30x60	.77.	35x53	.78.	
2	25x60	.04.	30x60	.63.	35x53	.60.	
2,5	30x53	.95..	30x60	.64.			
3	30x53	.82..	30x60	.09..	35x53	.93.	
3,15	30x53	.98..	30x60	.10..	35x53	.97.	
3 5	30x53	.99..	25x72	.08.			
4	30x60	.12.			35x53	.87.	
4 5	30x60	.13.			35x53	.96.	
5	30x72	.15	35x60	.17.	35x53	.94.	
6	30x72	.16	35x60	.18.			
6,3	35x60	.19.					
7	35x60	.20.					
7,5	35x72	.21					
8	35x72	.22					
9	35x72	.23					
10	35x77	.27	40x72	.28.			
12	40x72	.29.					
12,5	40x72	.30.					
13	40x72	.31.					
13,5	40x98	.38.					
14	40x98	.39.					
15	40x98	.40.					
16	40x98	.41.					
17,5	40x98	.42.					
18	40x98	.43.					
20	40x98	.44.					
22	45x98	.45.					
25	45x98	.46.					
30	45x122	.50	50x98	.47.			
31,5	45x122	.51	50x98	.48.			
35	45x122	.52	50x98	.49.			
40	50x122	.53.					
45	50x122	.55.					
50	55x122	.56.					
55	55x122	.57.					
60	55x122	.58.					
70	60x137	.86.					

Omologazioni / Approvals						
<b>Series 4.16.26</b>	EN 60252-1					 File E102953
	Tensione Voltage		ASE		Valori omologati Approved range	
	425V~ 450V~ 475V~ 500V~	30000h cl. A 30000h cl. A 10000h cl. B 3000h cl. C	25/85/21 25/85/21 25/85/21 25/85/21	30 ÷ 40uF 0,8 ÷ 25uF 30 ÷ 40uF 0,8 ÷ 25uF	Tensione Voltage 440V~ 60Hz 0,8÷60uF 10.000 AFC -25 +70°C	
Classe di sicurezza: P2 Class of safety protection: P2						
C (µF)	DxH (mm)	Part number 4.16.26.XX.KK	DxH (mm)	Part number 4.16.26.XX.KK	DxH (mm)	Part number 4.16.26.XX.KK
0,8	25x60	4.16.26.29.KK				
1	25x60	.30.	30x60	4.16.26.78.KK	35x53	4.16.26.80.KK
1,25	25x60	.58.				
1,5	25x60	.31.	30x60	.72.	35x53	.81.
1,8	25x60	.62.				
2	30x53	.79.	30x60	.73.	35x53	.69.
2,5	30x53	.84.	25x72	.33.	35x53	.77.
3	30x60	.36.	25x72	.34	35x53	.74.
3,15	30x60	.42.			35x53	.82.
3,5	30x72	.37.			35x53	.83.
4	30x72	.38.			35x53	.75.
4,5	30x72	.39.			35x60	.40.
5	35x60	.05.	30x77	.61.		
6	35x72	.06.				
6,3	35x72	.66.				
7	35x72	.07.				
7,5	35x72	.08.				
8	40x72	.09.	35x77	.56.		
9	40x72	.41.				
10	40x72	.10.				
12	40x98	.11.				
12,5	40x98	.12.				
13	40x98	.13.				
14	40x98	.14.				
15	40x98	.15.				
16	40x98	.16.				
17,5	45x98	.17.				
18	45x98	.18.				
20	45x98	.19.				
22	45x122	.55.				
22,5	45x122	.51.				
25	45x122	.20.	50x98	.52.		
30	50x122	.50.	55x98	.53.		
31,5	50x122	.22.				
35	50x122	.23.	55x98	.54.		
40	55x122	.24.				
45	55x132	.25.				
50	55x132	.26.				
55	60x137	.27.				
60	60x137	.28.				

Soluzioni meccaniche / Mechanical configuration

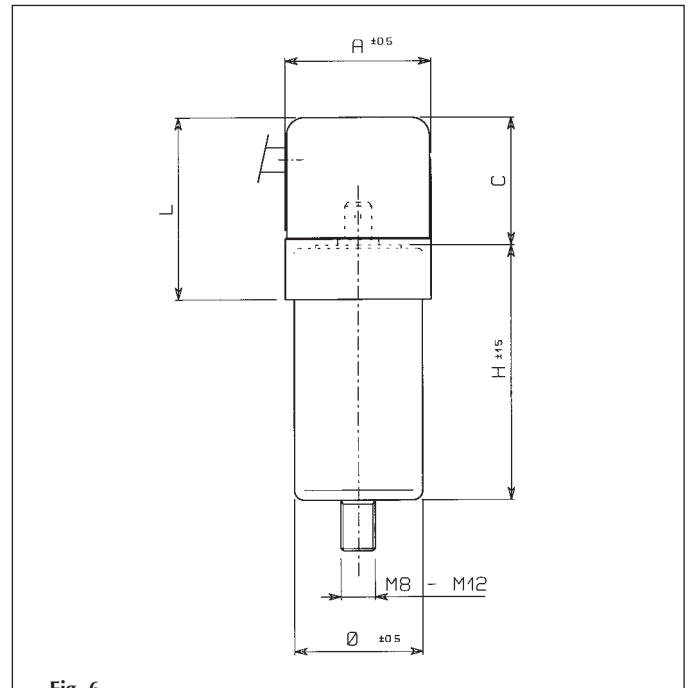
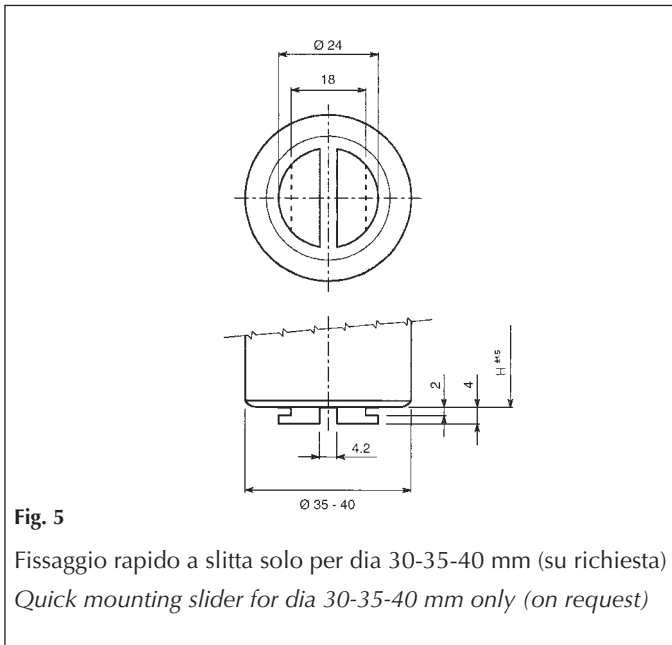
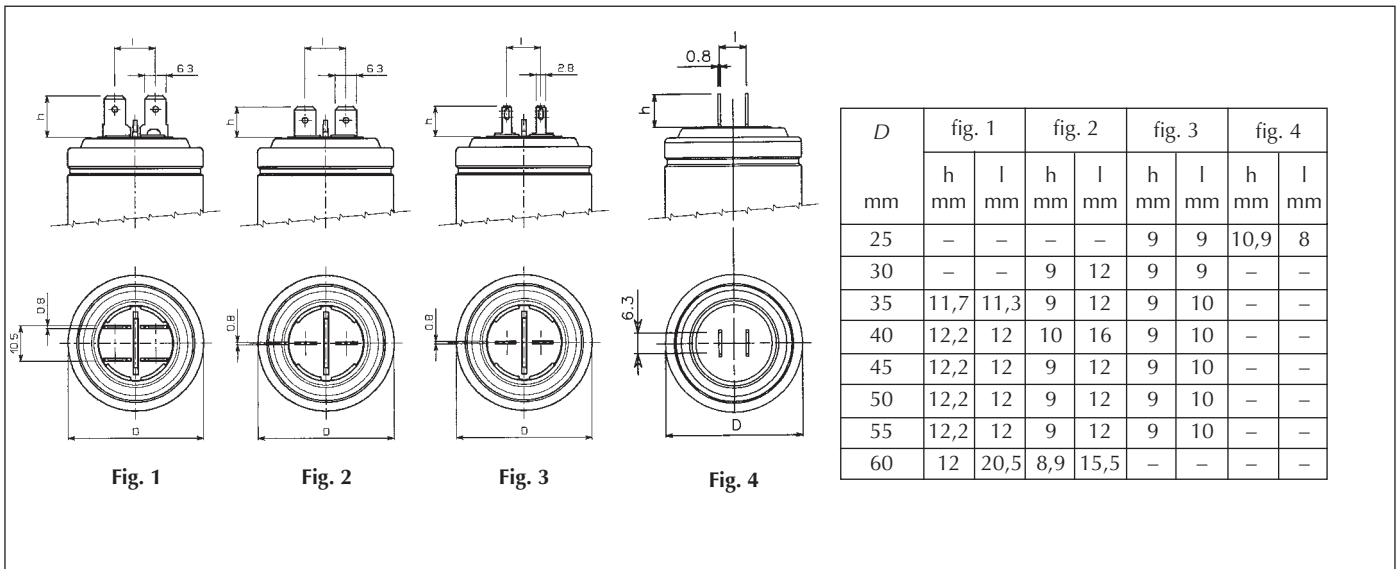

Accessori kk  
Accessories kk

Fig.	Descrizione Description	Serie - Series 4.16.27/.25/.33/.26	
		senza codolo without stud	con codolo with stud
1	FASTON 6,3 mm doppio / double tag	60	64
2-4	FASTON 6,3 mm semplice / single tag	28	29
3	Innesto da 2,8 mm 2.8 plug in	00	40
Ø25-30-35-40-45-50 Codolo M8 / M8 stud			
Ø 55-60 Codolo M12 / M12 stud			

Ø	A	C	L	Codice / Part number
25	29	32	45	316.23.2230
30	34,5	32	45,5	316.23.1030
35	39	32	52	316.23.1020
40	44	32	58	316.23.1040
45	49	32	58	316.23.1050

Cappello in plastica

## CARATTERISTICHE TECNICHE

Tolleranza di capacità	: $\pm 5\%$
Frequenza di lavoro	: 50/60 Hz
Tensione di prova individuale	: Fra le armature: 2 Vn per 2 sec.; verso massa: 3kV per 2 sec.
Angolo di perdita $\tan \delta$	: $\leq 20 \cdot 10^{-4}$ (20°C V=Vn, 50 Hz)
Rivestimento	: Custodia in alluminio con coperchio in materiale plastico autoestinguente, in accordo con UL94: autoestinguenza V2
Terminali	: Terminali Faston 6,3 mm singolo, dop- pio, a innesto da 2,8 mm Cavo bipolare
Grado di protezione	: Per esecuzioni con terminali: IP00
Coperchio porta-terminali	: Test della sfera (IEC 60695-10-2): 125°C Test del filo incandescente (IEC 60695-2-11): 850°C Resistenza alle correnti superficiali (IEC 60112): $\geq 250V$
Codolo filettato di fissaggio	: Coppia massima di serraggio: M8 = 5 N m; M12 = 12 N m
Dispositivo di sicurezza	: a sovrappressione (Fig. 7)

## TECHNICAL CHARACTERISTIC

Capacitance tolerance	: $\pm 5\%$
Working frequency	: 50/60 Hz
Individual test voltage	: Between terminals: 2 Vn for 2 sec.; betwe- en terminals and case: 3kV for 2 sec.
Dissipation factor $\tan \delta$	: $\leq 20 \cdot 10^{-4}$ (20°C V=Vn, 50 Hz)
Protection	: Aluminium case with plastic self extin- guishing sealing cover, according to UL 94 Standard, Grade V2
Terminals	: Faston terminals 6.3 mm single, double 2.8 mm plug-in. Twin cable
Protection degree	: With terminals: IP00
Cover	: Ball pressure test (IEC 60695-10-2): 125°C Glow wire test (IEC 60695-2-11): 850°C Tracking resistance (IEC 60112): $\geq 250V$
Threaded fixing bolt	: Max screwing torque: M8 = 5 N m; M12 = 12 N m
Safety device	: overpressure (Fig. 7)

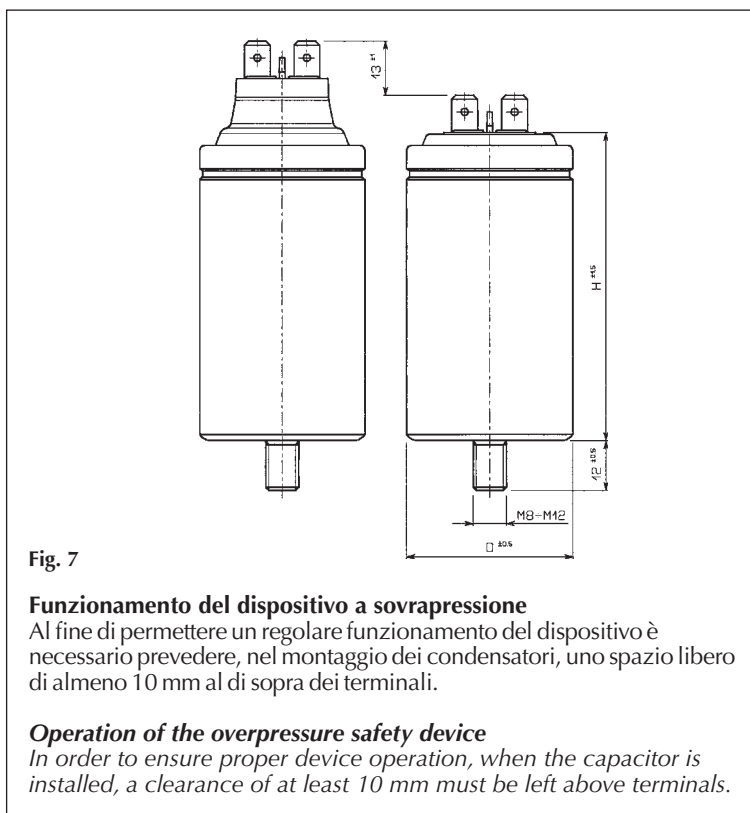

Fig. 7

### Funzionamento del dispositivo a sovrappressione

Al fine di permettere un regolare funzionamento del dispositivo è necessario prevedere, nel montaggio dei condensatori, uno spazio libero di almeno 10 mm al di sopra dei terminali.

### Operation of the overpressure safety device

In order to ensure proper device operation, when the capacitor is installed, a clearance of at least 10 mm must be left above terminals.

Questa protezione è stata ottenuta attraverso una particolare tecnologia costruttiva (brevettata), che in caso di guasto disattiva entrambi i collegamenti, lasciando integro l'isolamento verso la custodia e impedendo che il condensatore possa scoppiare o bruciare.

In caso di cortocircuito permanente, infatti, la corrente provoca la decomposizione del dielettrico con conseguente sviluppo di gas la pressione che si determina provoca il sollevamento della parte del coperchio supportante i terminali, interrompe le connessioni interne e quindi il passaggio di corrente. (Fig. 7)

Il dispositivo è stato studiato e dimensionato in modo diverso per ogni dimensione per rendere più efficace e tempestivo l'intervento con basse e con alte correnti di cortocircuito (fino a 10.000 A.). Il sistema antiscoppio brevettato, non prevedendo un allungamento della custodia ma solo della parte centrale del coperchio (vedi Fig. 7), permette l'utilizzo di sistemi di fissaggio di tipo americano (Dog-house Clamps).

This protection is provided by a special construction technology (patented) which breaks both the connections in case of breakdown, without affecting case insulation, preventing the capacitor from exploding or burning.

In case of permanent short-circuit, the current causes the dielectric to decompose, forming gas: the resulting pressure pushes up the part of the lid where the terminals are mounted, thus breaking the internal connections and stopping the current flow. (Fig. 7)

The device is designed in different sizes for each size of capacitor for the most effective, fastest intervention with both high and low short-circuit currents (up to 10.000 A).

In order to ensure proper operation of the device when the capacitor are installed, an empty space of at least 10 mm must be left above the terminals.

Because the new patented safety device is acting in the central part of the plastic deck only (see Fig. 7), it is possible to fix the capacitor with the system in use in the U.S.A. (Dog-house Clamps).

## Condensatori elettrolitici per avviamento motori monofase serie 4.12.80

## Single phase motor starting electrolytic capacitors series 4.12.80



I condensatori elettrolitici vengono normalmente impiegati nei motori monofase ad induzione per aumentare il valore della coppia d'avviamento. Si richiede che tale avviamento avvenga in una frazione di secondo o al massimo di qualche secondo e con l'apporto di una elevata potenza reattiva.

Il condensatore elettrolitico, per le dimensioni ridotte e gli elevati valori di capacità, è il condensatore ideale per questo tipo di servizio.

Naturalmente una volta esaurita la fase di avviamento, il condensatore deve essere scollegato dal circuito.

L'elemento capacitivo è realizzato con fogli di alluminio «formato» e separati da uno strato di carta impregnata di elettrolita; le custodie sono stampate in materiale termoplastico, i terminali sono del tipo a saldare ed a innesto.

*Electrolytic capacitors are normally employed in single-phase induction motors in order to increase the value of their starting torque.*

*It is necessary that such starting should take place in a fraction of a second or at the most in a few seconds and with the contribution of an high reactive power.*

*Because of its reduced size, high capacitance value, the electrolytic capacitor is the suitable capacitor for this type of application.*

*Of course, once the motor has been started, the capacitor must be disconnected from the circuit.*

*The capacitive element is made of aluminium foils «treated» and separated by a leaf of impregnated paper as the electrolyte. Cases moulded in thermoplastic material, terminals tinned soldering and flat plug type.*

## Serie standard per usi generali / Standard duty series for general application

Capacità Capacitance µF	110V ~		125V ~		165V ~		220V ~		250V ~		280V ~		330V ~	
	C min C max Cn. (Toll.)	Dim. Codice Part number 4.12.80.y.xxx	Dim. Codice Part number 4.12.80.y.xxx	Dim. Codice Part number 4.12.80.y.xxx	Dim. Codice Part number 4.12.80.y.xxx	Dim. Codice Part number 4.12.80.y.xxx	Dim. Codice Part number 4.12.80.y.xxx	Dim. Codice Part number 4.12.80.y.xxx	Dim. Codice Part number 4.12.80.y.xxx	Dim. Codice Part number 4.12.80.y.xxx	Dim. Codice Part number 4.12.80.y.xxx	Dim. Codice Part number 4.12.80.y.xxx	Dim. Codice Part number 4.12.80.y.xxx	Dim. Codice Part number 4.12.80.y.xxx
21÷25	A	4.12.80.y.201	A	4.12.80.y.251	A	4.12.80.y.301	A	4.12.80.y.351	A	4.12.80.y.401	A	4.12.80.y.501	A	4.12.80.y.451
25÷30	»	.202	»	.252	»	.302	»	.352	»	.402	»	.502	»	.452
30÷36	»	.203	»	.253	»	.303	»	.353	»	.403	»	.503	»	.453
36÷43	»	.204	»	.254	»	.304	»	.354	»	.404	»	.504	»	.464
43÷52	»	.205	»	.255	»	.305	»	.355	»	.405	»	.505	»	.472
47÷56	»	.206	»	.256	»	.306	»	.356	»	.406	»	.506	B	* .456
53÷64	»	.207	»	.257	»	.307	»	.357	»	.418	»	.523	»	* .457
64÷77	»	.208	»	.258	»	.308	»	.370	»	.427	B	* .508	»	* .458
72÷86	»	.209	»	.259	»	.309	»	.376	B	* .409	»	* .509	»	* .459
88÷106	»	.210	»	.260	»	.310	B	* .360	»	* .410	»	* .510	»	.465
108÷130	»	.211	»	.261	»	.311	»	* .361	»	* .411	»	* .518	C	.461
124÷149	»	.212	»	.262	»	.334	»	* .362	»	* .419	»	.533	»	.462
130÷156	»	.213	»	.263	»	.335	»	* .371	»	* .420	»	.534	»	.463
145÷174	»	.214	»	.264	»	.336	»	* .372	»	.421	»	.535	»	.469
161÷193	»	.215	»	.265	B	* .315	»	* .373	»	.422	C	.515	»	.468
189÷227	»	.216	»	.266	»	* .316	»	.377	»	.424	»	.520	»	.466
216÷260	»	.217	»	.267	»	* .317	»	.378	C	.417	»	.522	D	.603
233÷280	»	.218	»	.268	»	* .318	C	.368	»	.423	»	.524	»	.604
243÷292	»	.219	»	.275	»	* .319	»	.369	»	.428	D	.540	»	.605
270÷324	»	.227	B	* .270	»	* .337	»	.375	»	.436	»	.541	»	.606
324÷389	B	* .221	»	* .271	»	* .338	»	.379	»	.437	»	.542		
340÷408	»	* .222	»	* .272	»	.339	»	.380						
378÷454	»	* .223	»	* .273	»	.340								
400÷480	»	* .224	»	* .274	C	.333								
430÷516	»	* .225	»	* .276										
460÷552	»	* .226	»	* .284										
550÷650	»	* .228	»	.285										

\* Disponibile anche in dimensioni E / Also available in E dimensions

## Serie speciale per impieghi industriali / Heavy duty series for industrial applications

**Omologati / Approved**

Temperature class: - 20 + 60°C

VDE



IMQ



EN 60 252-2



E192559

Capacità Capacitance µF	250 V ~		330 V ~	
	DIM.	Codice / Part number 4.12.80.y.xxx	DIM.	Codice / Part number 4.12.80.y.xxx
24 ± 10%	A	4.12.80.y.107	A	4.12.80.y.121
48 ± 10%	»	.112	»	.133
50 ± 10%	»	.116	»	.153
56 ± 10%	»	.109	B	* .101
59 ± 10%	»	.110	»	* .102
71 ± 10%	»	.105	»	* .124
80 ± 10%	B	* .114	»	* .126
98 ± 10%	»	* .106	»	.134
120 ± 10%	»	* .119	C	.165
140 ± 10%	»	* .117	»	.120

Dimensioni  
Dimensions

A = 36,5 x 68,5 mm  
B = 45,5 x 84 mm  
C = 52 x 105 mm  
D = 65 x 111 mm  
E = 38 x 89 mm

## CARATTERISTICHE TECNICHE

Tolleranza di capacità	: ± 10%
Rivestimento	: Custodia stampata in materiale termoplastico autoestinguente
Terminali	: A saldare o Faston 6,3 mm doppi
Dielettrico armature	: Foglio di alluminio inciso
Applicazioni	: Avviamento motori monofase
Temperatura di lavoro	: -20°C + 55°C VDE: -20°C + 60°C
Fattore di dissipazione	: Tipico 6% - Massimo 10%
Ciclo nominale di funzionamento	: 3'/1.7% :3s ON/3 min OFF (N=20 inserzioni-ora della durata t=3": N.t = 60)
Estensione del ciclo di funzionamento	: Questi condensatori possono sopportare cicli di funzionamento più gravosi del ciclo nominale della serie. Per temperature inferiori alla temperatura di lavoro il prodotto N.t può essere moltiplicato per i fattori sottoindicati:

Temp. ambiente	55°C	45°C	35°C	25°C	15°C
Fattore	1	1.25	1.5	1.75	2

## TECHNICAL CHARACTERISTIC

Capacitance tolerance	: ± 10%
Protection	: Moulded thermoplastic self-extinguishing
Terminals	: Tinned soldering or 6.3 mm double tags
Construction	: Etched aluminium foil
Applications	: Starting of single phase motor
Operating temperature range	: -20°C + 55°C VDE: -20°C + 60°C
Dissipation factor	: Typical 6% - Maximum 10%
Duty cycle	: 3'/1.7% :3s ON/3 min OFF (N=20 hour application time t=3": N.t = 60)
Extension of duty cycle	: These capacitors withstand heavier duty cycles than the rated one. For the below temperature operating, the product N.t can be multiplied by the following factors:

Room temperature	55°C	45°C	35°C	25°C	15°C
Factor	1	1.25	1.5	1.75	2

### Realizzazioni standard / Standard Models

D cond	P	H	E
36,5	16	68,5	1,75
45,5	16	84	2,55
52	16	105	5,55
38	13	89	0
65	16	111	-

**Fig. 1** Terminali a saldare  
**Fig. 1** Soldering terminals

**Fig. 2** Terminali faston 6,3 mm doppi  
**Fig. 2** Double 6.3 mm terminals

**Fig. 3** Terminali faston 6,3 mm tripli  
**Fig. 3** Triple 6.3 mm terminals

### Accessori y Accessories y

Fig.	Descrizione Description	Serie / Series 4.12.80	
		Senza codolo Without stud	Con codolo With stud
1	Terminali a saldare Soldering terminals	0	1
2	Faston 6,3 mm. doppio 6,3 mm. double tag	2	3

A richiesta disponibili resistenze da 15÷39 Kohm, 1 watt / Resistor 15÷39 Kohm, 1 watt is mounted on request

Staffa di fissaggio / *Mounting bracket*

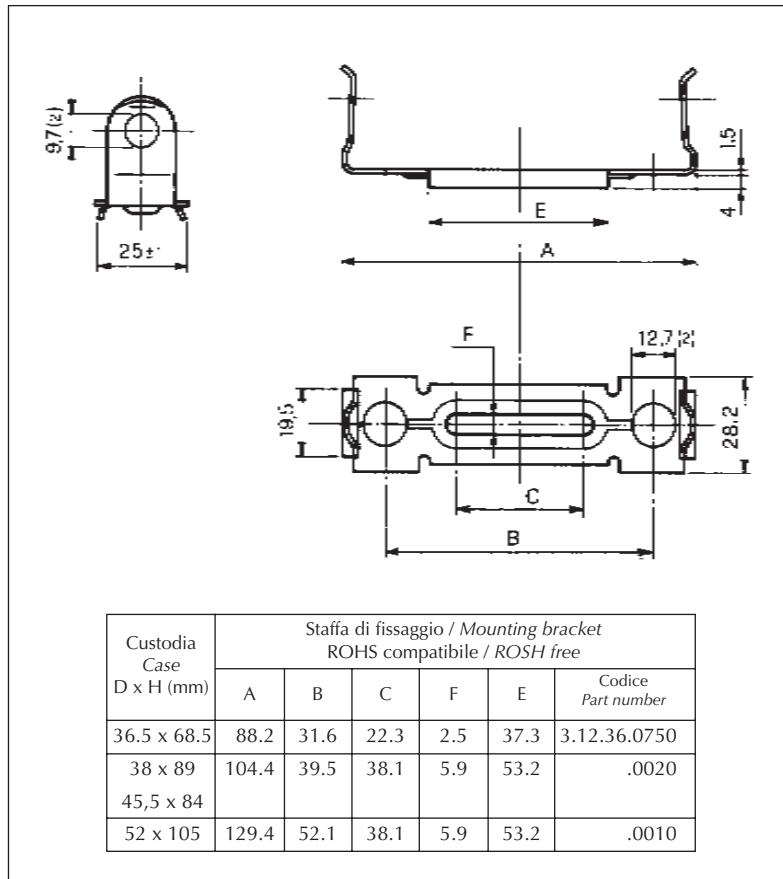

Coperchio di protezione / *Protective cap*

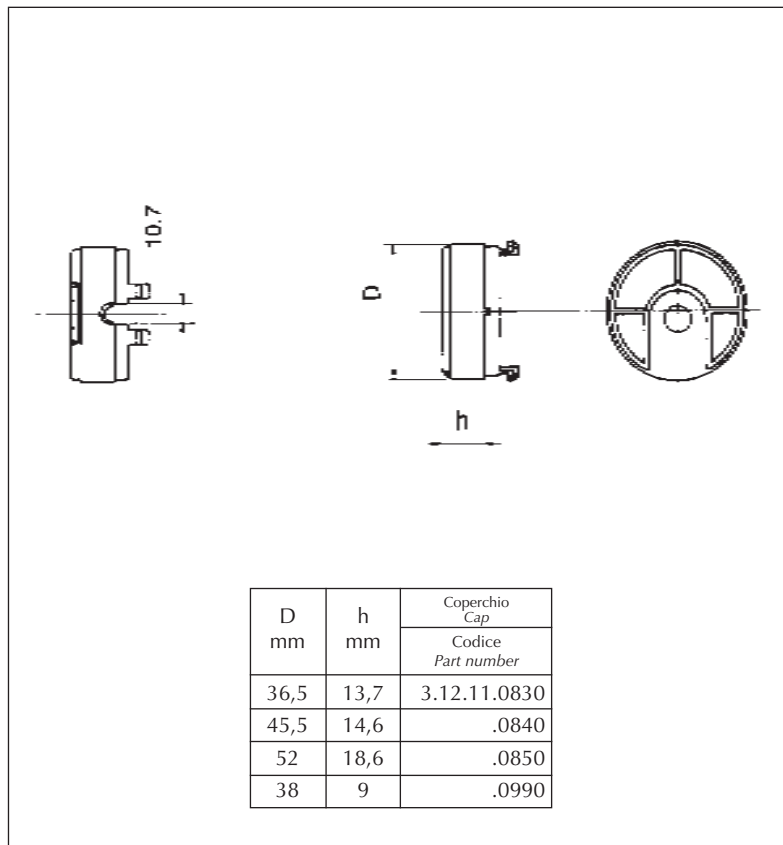

## Serie / Series 4.16.18/.10/.17/.20/.87

In custodia di plastica / Plastic case

Dimensione condensatore D x H (mm) Capacitor's dimensions	Esecuzioni con terminali With tags	D*	Esecuzione con cavetti With leads		Esecuzione con cavi With cables	
			L < 200 mm.	D*	L ≥ 200 mm.	D*
25 x 49	250 pz.	A	250 pz.	A	200 pz.	A
25 x 55	250 pz.	A	200 pz.	A	125 pz.	B
28 x 55	250 pz.	A	200 pz.	A	125 pz.	A
30 x 56.5	200 pz.	A	200 pz.	A	125 pz.	A
30 x 70	125 pz.	B	125 pz.	B	100 pz.	A
32 x 55	200 pz.	A	125 pz.	B	100 pz.	A
36 x 58	125 pz.	A	125 pz.	A	100 pz.	A
36 x 70	100 pz.	A	100 pz.	A	50 pz.	B
40 x 70	100 pz.	A	50 pz.	B	50 pz.	B
40 x 92	50 pz.	B	50 pz.	A	50 pz.	A
45 x 70	50 pz.	B	50 pz.	A	50 pz.	A
45 x 92	50 pz.	A	50 pz.	A	25 pz.	B
45 x 117	25 pz.	B	25 pz.	B	25 pz.	B
50 x 92	25 pz.	B	25 pz.	B	25 pz.	B
50 x 117	25 pz.	A	25 pz.	A	25 pz.	A
55 x 92	25 pz.	A	25 pz.	A	25 pz.	A
55 x 120	25 pz.	A	25 pz.	A	25 pz.	A
60 x 120	20 pz.	A	20 pz.	A	20 pz.	A
Peso / Weight	8 ÷ 9 Kg.		6,5 ÷ 8 Kg.		7 ÷ 8 Kg.	

Tutte le dimensioni sono confezionate alla rinfusa / All of the capacitors dimensions are packet in bulk.

## Serie / Series 4.16.27/.25/.33/.26

In custodia metallica / Metallic case

Dimensioni condensatore Capacitor's dimensions D x H (mm)	Esecuzione con terminali With tags	D*
25 x 60	250	A
25 x 72	200	B
30 x 53	200	B
30 x 60	200	A
30 x 72	125	B
35 x 53	125	B
35 x 60	125	A
35 x 72	100	B
35 x 77	100	B
40 x 72	100	A
40 x 98	50	B
45 x 98	50	A
45 x 122	25	B
50 x 122	25	B
55 x 122	25	A
55 x 132	25	A
60 x 103	25	A
60 x 137	25	A

## Serie / Series 4.12.80

Dimensioni condensatore D x H (mm) Capacitor's dimensions	36,5 x 68,5	38 x 89	45,5 x 84	52 x 105	65 x 111	Peso / Weight
Esecuzione con terminali With tags	100 pz.	50 pz.	50 pz.	50 pz.	25 pz.	6 ÷ 7 Kg.
Dimensioni scatole * Dimensions box *	B	B	A	A	A	

\* Dimensioni scatole / Standard box dimensions: A = mm 195 x 390 x 255 B = mm 195 x 390 x 200

### Numero di scatole per europallet (dimensione 1200 mm x 800 mm)

Con scatola dimensione 195 x 390 x 255 : N. 36 scatole

Con scatola dimensione 195 x 390 x 200 : N. 48 scatole

### Number of boxes per europallet (dimension: 1200 mm x 800 mm)

Box with dimension: 195 x 390 x 255: N. 36 boxes

Box with dimension: 195 x 390 x 200: N. 48 boxes



CONDENSATORI  
PER MOTORI

MOTOR  
CAPACITORS

**ELDIS**

ELDIS Ehmki & Schmid OHG

Straßfeld 1  
D-85777 Fahrenzhausen

Fon +49 8133 - 444 22 • 0  
Fax +49 8133 - 444 22 • 11

info@eldis.de  
www.eldis.de



**DUCCATI** energia

Via M.E. Lepido, 182 - 40132 Bologna - Italy  
Tel. +39 051 6411511 - Fax. +39 051 402040  
www.ducatienergia.com - E-mail: commcon@ducatienergia.com